

PHASE/OFF



The Phase / Off is a four-stage phaser based around the Sound Semiconductor SSI2140 voltage-controlled multi-mode filter. This pedal offers classic phasing effects along with plenty of control to dial in the perfect amount of modulation using the *Depth*, *Rate*, and *Regen* knobs. The *Stages* switch can change the Phase / Off from four-stage phaser to a two-stage phaser providing a wide variety of different phasing sounds. Change the *Mode* switch from *LFO* to *Manual* to use the Phase / Off in fixed phase mode controlled by the *Depth* knob for unique filtering effects.

The Phase / Off pedal kit is the second entry in the Nexus Series from Mod® Electronics. This series features a PCB base rather than the Mod® Electronics' traditional point-to-point wiring kits to offer builders an even wider variety of effects to build. The Phase / Off is a great pedal for intermediate skill sets. It features an all through-hole build with pre-soldered SMT SSI2140.

The pedal operates on 9VDC. A center negative power supply is required for use (not included with kit). There is no battery connection. The pedal draws ~50mA. The enclosure size is a standard 1590BB (4.7" x 3.7" x 1.34").



Table of Contents

Section	Page
Notes on PCB Construction	2
Parts Lists	3-7
PCB Bill of Materials	8-11
Applying The Sticker	12
Main PCB Construction	13-18
Footswitch PCB Construction	19
Jack PCB Construction	20
Final Assembly	21-23
Phase / Off Controls	24
Schematic	25-27

Required Tools

Adjustable Wrench
Cutters
Lead Formers
Needlenose Pliers
Phillips Head Screwdriver
Ruler
Small Flat Head Screwdriver
Solder
Soldering Iron
Wire Stripper
Xacto Knife or Similar Cutting Tool

Optional Recommended Tools

Anti-static Wrist Strap
Desoldering Braid
Desoldering Pump
Helping Hands
Multimeter
Oscilloscope
PCB Vise
Signal Generator
Tweezers

Notes on PCB Construction

This section is intended for those unfamiliar or new to constructing circuit boards.

Lead Spacing

Components are made in two common mounting types, radial and axial. Radial components feature leads that are parallel and oriented in the same direction whereas the leads of axial components protrude from each end of the component oriented in opposite directions.

These parts will have corresponding footprints on the PCB marked with text. C_ designates a capacitor and R_ is used for resistors. The BOM will cover all of the designators. Each footprint has a specific spacing. Footprints for the radial parts will match the spacing of that part but axial parts require preparation to fit. For the resistors in this kit you can simply use your finger to push the lead until it is perpendicular where the lead meets the part. Other axial parts will have different lead spacings. Use a lead former tool on these parts.



Soldering

After inserting the PCB into its footprint, make sure that the component is sitting flush against the PCB. Hold it in place and bend the leads on the opposite side of the PCB away from the component. This will keep the component flush to the PCB when soldering.

Make sure your soldering iron is fully warmed up before soldering. Position the tip of the iron so that it is touching both the solder pad of the PCB and the lead of the component. Slowly feed solder onto the pad. The solder should flow evenly across the pad and will slope up onto the component lead. You may need to move the end of the solder strand around the pad to ensure that the pad is fully coated in solder and that it is also bonding to the lead. Repeat this process for each lead of the component then use a pair of cutters to snip the lead directly above the peak of the solder.

Ideally the solder will flow through the pad hole and a small amount will reach the opposite side of the PCB. This can take some practice to master and is not critical. Focus on consistently achieving full coverage of the pad with slight slopes surrounding the lead first.

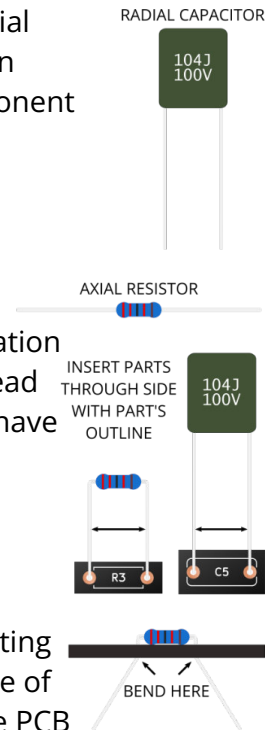
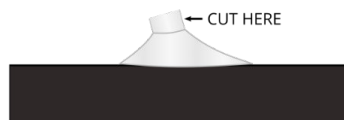

Main PCB Parts List

 R-N100 Qty 2 100Ω 1/4W Metal Film Resistor

 R-N200 Qty 4 200Ω 1/4W Metal Film Resistor

 R-N1K Qty 1 1KΩ 1/4W Metal Film Resistor

 R-N3K Qty 1 3KΩ 1/4W Metal Film Resistor

 R-N5D1K Qty 1 5.1KΩ 1/4W Metal Film Resistor

 R-N8D2K Qty 1 8.2KΩ 1/4W Metal Film Resistor

 R-N10K Qty 15 10KΩ 1/4W Metal Film Resistor

 R-N13K Qty 1 13KΩ 1/4W Metal Film Resistor

 R-N16K Qty 1 16KΩ 1/4W Metal Film Resistor

 R-N18K Qty 1 18KΩ 1/4W Metal Film Resistor

 R-N33K Qty 2 33KΩ 1/4W Metal Film Resistor

















 R-N47K Qty 2 47KΩ 1/4W Metal Film Resistor

 R-N51K Qty 1 51KΩ 1/4W Metal Film Resistor

 R-N100K Qty 1 100KΩ 1/4W Metal Film Resistor

 R-N1M Qty 1 1MΩ 1/4W Metal Film Resistor

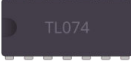
Main PCB Parts List (cont.)

	P-Q971	Qty 2	1N4148 Small Signal Diode
	P-Q1N5817	Qty 1	1N5817 Schottky Diode
 TOP DOWN VIEW	C-R82-1N	Qty 4	1nF Box Film Capacitor
 TOP DOWN VIEW	C-R82-1N5	Qty 1	1.5nF Box Film Capacitor
 TOP DOWN VIEW	C-R82-100N	Qty 1	100nF (.1uF) Box Film Capacitor
 TOP DOWN VIEW	C-R82-470N	Qty 2	470nF (.47uF) Box Film Capacitor
 TOP DOWN VIEW	C-D10P-50	Qty 1	10pF Ceramic Capacitor
 TOP DOWN VIEW	C-D47P-50	Qty 1	47pF Ceramic Capacitor
 TOP DOWN VIEW	C-CD470-500	Qty 1	470pF Ceramic Capacitor
 TOP DOWN VIEW	C-D100N-50	Qty 6	100nF Ceramic Capacitor
 TOP DOWN VIEW	C-ETR100-25	Qty 3	100uF Electrolytic Capacitor
 TOP DOWN VIEW	P-Q2N2222A-92	Qty 1	2N2222A NPN Transistor
	P-QLM311	Qty 1	LM311 Comparator, 8-Pin DIP
	P-QLT1054	Qty 1	LT1054 Voltage Converter IC, 8-Pin DIP
	P-QTL074	Qty 1	TL074 Quad Op Amp IC, 14-Pin DIP
	P-STIC-8	Qty 2	8-Pin DIP Socket
	P-STIC-14	Qty 1	14-Pin DIP Socket

Main PCB Parts List (cont.)

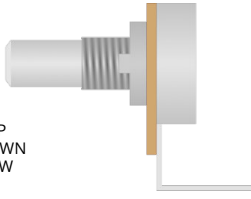
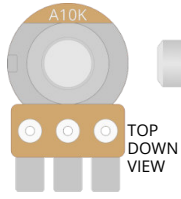

R-VAM10KA-SS-PCL Qty 1 A10KΩ 16mm PCB Mount Potentiometer

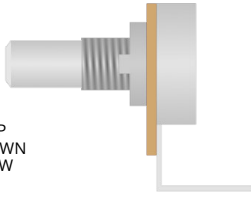
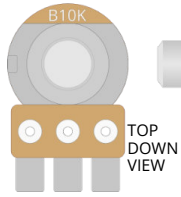

R-VAM10KL-SS-PCL Qty 1 B10KΩ 16mm PCB Mount Potentiometer

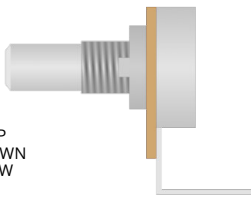
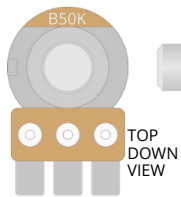

R-VAM50KL-SS-PCL Qty 1 B50KΩ 16mm PCB Mount Potentiometer

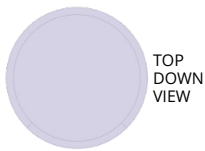

R-VCOVER-LP16 Qty 1 16mm Potentiometer Cover

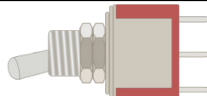

P-H5411 Qty 1 SPDT Mini Toggle

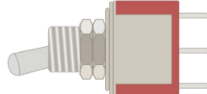

P-H5410 Qty 1 DPDT Mini Toggle

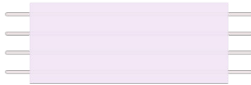

S-W88-4-1 Qty 1 4 Conductor Flexstrip Ribbon Cable

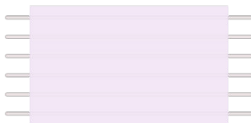

S-W88-6-1 Qty 1 6 Conductor Flexstrip Ribbon Cable

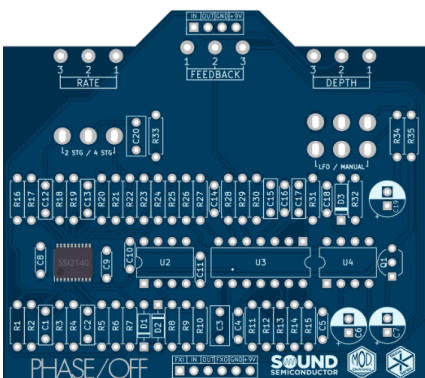

K-905-PCB-MAIN Qty 1 Main PCB with presoldered SSI2140 IC

Footswitch PCB Parts List



R-G1K

Qty1

1KΩ 1/8W Metal Film Resistor



TOP
DOWN
VIEW



P-L353

Qty 1

Blue 5mm Diffused LED Schottky Diode



P-L710-BLU

Qty 1

Blue LED Lens

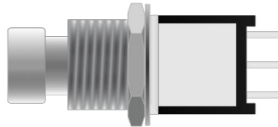

P-H501-LP

Qty 1

Low Profile 3PDT Footswitch

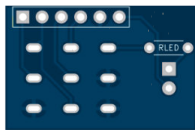

K-905-PCB-SWITCH

Qty 1

Footswitch PCB

Jack PCB Parts List

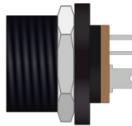

P-JBCL-EN-S

Qty 1

DC Barrel Jack

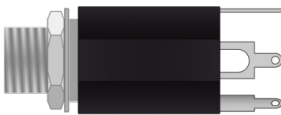

S-H534

Qty 2

1/4" Jack



S-W3024TC-BK-50

1ft

Black 24AWG Stranded Top Coat Wire



S-W3024TC-W-50

1ft

White 24AWG Stranded Top Coat Wire

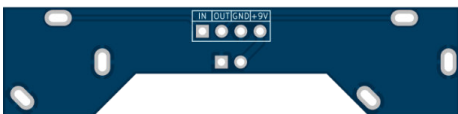

K-905-PCB-JACK

Qty 1

Jack PCB

Enclosure Parts List

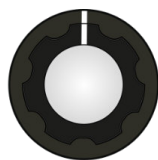

P-K371

Qty 1 Small Knob



P-K381

Qty 2 Large Knob

P-H1590BBCE Qty 1 Aluminum 1590BB Enclosure

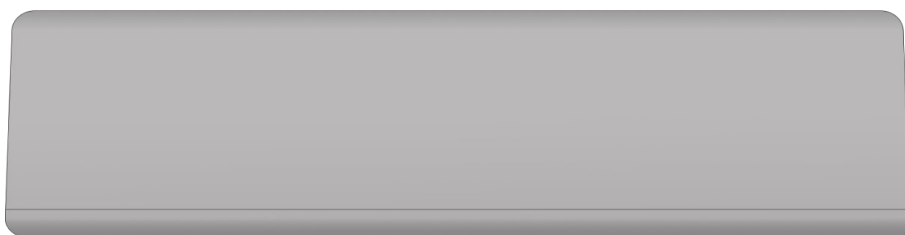

K-905-LABEL Qty 1 Phase / Off Sticker



Main PCB

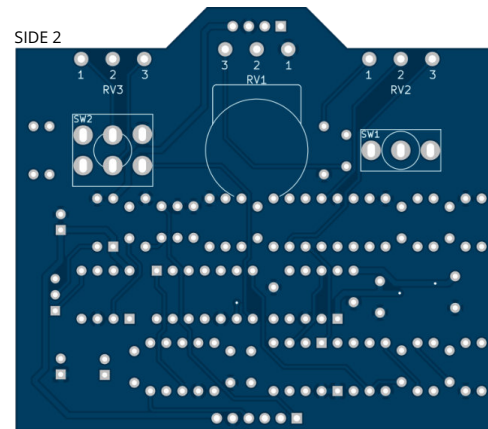
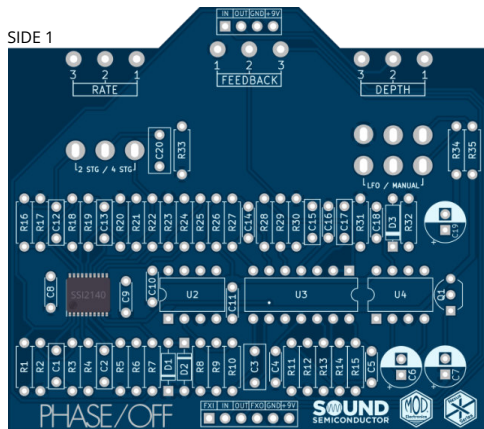

✓	Part	Value	Type
<input type="checkbox"/>	R1	10KΩ	1/4W Metal Film Resistor
<input type="checkbox"/>	R2	200Ω	1/4W Metal Film Resistor
<input type="checkbox"/>	R3	10KΩ	1/4W Metal Film Resistor
<input type="checkbox"/>	R4	10KΩ	1/4W Metal Film Resistor
<input type="checkbox"/>	R5	200Ω	1/4W Metal Film Resistor
<input type="checkbox"/>	R6	10KΩ	1/4W Metal Film Resistor
<input type="checkbox"/>	R7	33KΩ	1/4W Metal Film Resistor
<input type="checkbox"/>	R8	10KΩ	1/4W Metal Film Resistor
<input type="checkbox"/>	R9	5.1KΩ	1/4W Metal Film Resistor
<input type="checkbox"/>	R10	33KΩ	1/4W Metal Film Resistor
<input type="checkbox"/>	R11	10KΩ	1/4W Metal Film Resistor
<input type="checkbox"/>	R12	10KΩ	1/4W Metal Film Resistor
<input type="checkbox"/>	R13	13KΩ	1/4W Metal Film Resistor
<input type="checkbox"/>	R14	8.2KΩ	1/4W Metal Film Resistor
<input type="checkbox"/>	R15	100Ω	1/4W Metal Film Resistor
<input type="checkbox"/>	R16	10KΩ	1/4W Metal Film Resistor
<input type="checkbox"/>	R17	200Ω	1/4W Metal Film Resistor
<input type="checkbox"/>	R18	10KΩ	1/4W Metal Film Resistor
<input type="checkbox"/>	R19	10KΩ	1/4W Metal Film Resistor

PCB BOMs

Main PCB (cont.)

✓	Part	Value	Type
<input type="checkbox"/>	R20	200Ω	1/4W Metal Film Resistor
<input type="checkbox"/>	R21	10KΩ	1/4W Metal Film Resistor
<input type="checkbox"/>	R22	16KΩ	1/4W Metal Film Resistor
<input type="checkbox"/>	R23	1KΩ	1/4W Metal Film Resistor
<input type="checkbox"/>	R24	100KΩ	1/4W Metal Film Resistor
<input type="checkbox"/>	R25	51KΩ	1/4W Metal Film Resistor
<input type="checkbox"/>	R26	10KΩ	1/4W Metal Film Resistor
<input type="checkbox"/>	R27	10KΩ	1/4W Metal Film Resistor
<input type="checkbox"/>	R28	10KΩ	1/4W Metal Film Resistor
<input type="checkbox"/>	R29	18KΩ	1/4W Metal Film Resistor
<input type="checkbox"/>	R30	10KΩ	1/4W Metal Film Resistor
<input type="checkbox"/>	R31	1MΩ	1/4W Metal Film Resistor
<input type="checkbox"/>	R32	3KΩ	1/4W Metal Film Resistor
<input type="checkbox"/>	R33	100Ω	1/4W Metal Film Resistor
<input type="checkbox"/>	R34	47KΩ	1/4W Metal Film Resistor
<input type="checkbox"/>	R35	47KΩ	1/4W Metal Film Resistor
<input type="checkbox"/>	D1	1N4148	1N4148 Small Signal Diode
<input type="checkbox"/>	D2	1N4148	1N4148 Small Signal Diode
<input type="checkbox"/>	D3	1N5817	1N5817 Schottky Diode
<input type="checkbox"/>	C1	1nF	Film Capacitor
<input type="checkbox"/>	C2	1nF	Film Capacitor
<input type="checkbox"/>	C3	470nF	Film Capacitor
<input type="checkbox"/>	C4	100nF	Ceramic Capacitor
<input type="checkbox"/>	C5	47pF	Ceramic Capacitor
<input type="checkbox"/>	C6	100uF	Electrolytic Capacitor
<input type="checkbox"/>	C7	100uF	Electrolytic Capacitor

PCB BOMs

Main PCB (cont.)

	Part	Value	Type
<input type="checkbox"/>	C8	100nF	Ceramic Capacitor
<input type="checkbox"/>	C9	100nF	Ceramic Capacitor
<input type="checkbox"/>	C10	100nF	Ceramic Capacitor
<input type="checkbox"/>	C11	100nF	Ceramic Capacitor
<input type="checkbox"/>	C12	1nF	Film Capacitor
<input type="checkbox"/>	C13	1nF	Film Capacitor
<input type="checkbox"/>	C14	470pF	Ceramic Capacitor
<input type="checkbox"/>	C15	1.5nF	Film Capacitor
<input type="checkbox"/>	C16	100nF	Ceramic Capacitor
<input type="checkbox"/>	C17	100nF	Film Capacitor
<input type="checkbox"/>	C18	10pF	Ceramic Capacitor
<input type="checkbox"/>	C19	100uF	Electrolytic Capacitor
<input type="checkbox"/>	C20	470nF	Film Capacitor
<input type="checkbox"/>	Q1	2N2222	NPN Transistor
<input checked="" type="checkbox"/>	U1	SSI2140	Sound Semi Multi-Mode VCF
<input type="checkbox"/>	U2	LM311	DIP-8 High Speed Comparator
<input type="checkbox"/>	U3	TL074	DIP-14 Quad Op Amp
<input type="checkbox"/>	U4	LT1054	DIP-8 Voltage Converter
<input type="checkbox"/>	SW1	SPDT	2 Position SPDT Mini Toggle Switch
<input type="checkbox"/>	SW2	DPDT	2 Position DPDT Mini Toggle Switch
<input type="checkbox"/>	RV1	B10K Ω	16mm PCB Mount Potentiometer
<input type="checkbox"/>	RV2	A10K Ω	16mm PCB Mount Potentiometer
<input type="checkbox"/>	RV3	B50K Ω	16mm PCB Mount Potentiometer

PCB BOMs

Switch PCB

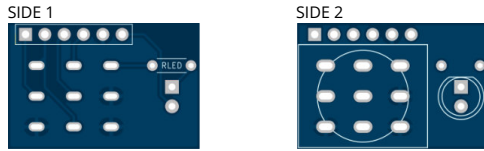

✓	Part	Value	Type
<input type="checkbox"/>	RLED	1K Ω	1/8W Metal Film Resistor
<input type="checkbox"/>	LED	Blue	5mm Diffused LED
<input type="checkbox"/>	Footswitch	3PDT	Low Profile 3PDT Footswitch
<input type="checkbox"/>	Ribbon Cable	6 Conductor	6 Conductor Flexstrip Ribbon

Jack PCB

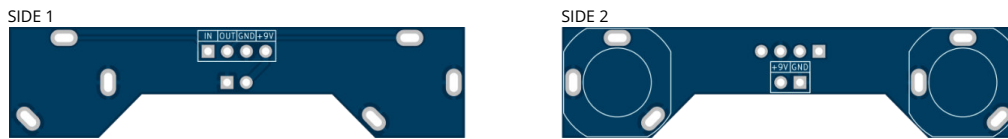

✓	Part	Value	Type
<input type="checkbox"/>	Input Jack	1/4" Jack	1/4" PCB Mount Jack
<input type="checkbox"/>	Output Jack	1/4" Jack	1/4" PCB Mount Jack
<input type="checkbox"/>	Ribbon Cable	4 Conductor	4 Conductor Flexstrip Ribbon
<input type="checkbox"/>	Ground Wire	Black	Pretinned 24AWG Wire
<input type="checkbox"/>	+9V Wire	Red	Pretinned 24AWG Wire

Applying The Sticker

Note: Do not apply the sticker until directed to do so at Step 73 in the instructions.

Locate the top of the pedal as well as the top of the sticker. The cover of the instructions for your kit will have an image of the pedal that can be used for reference.

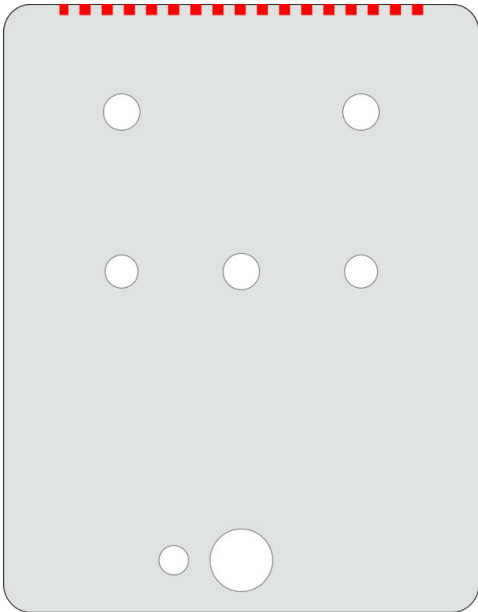

Peel the backing from the sticker. Carefully line up the top edge of the sticker with the top of the pedal. Press down to apply the sticker only to the edge. Run a finger across the edge to push any air out from beneath the sticker. Continue this motion as you work your way down the pedal until the sticker is fully attached.

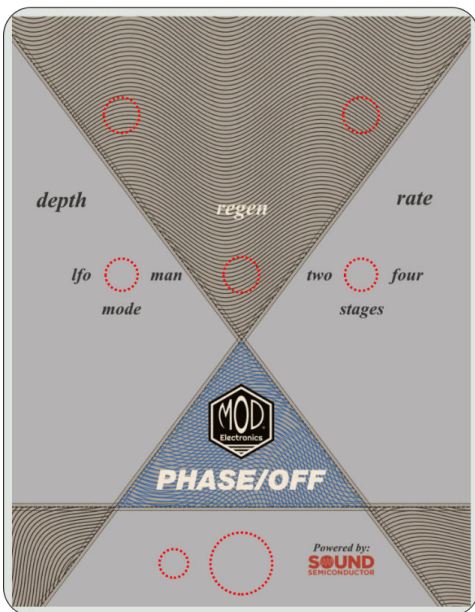

Locate the holes beneath the sticker and depress them using a fingertip. Be sure that the area of the sticker surrounding the holes is fully adhered to the surface.

With an Xacto knife or similar tool, carefully pierce the sticker in the center of each hole. Carefully work the knife from the center of the hole to the edge and begin cutting fully around the edge until the sticker has been fully cleared from the hole.

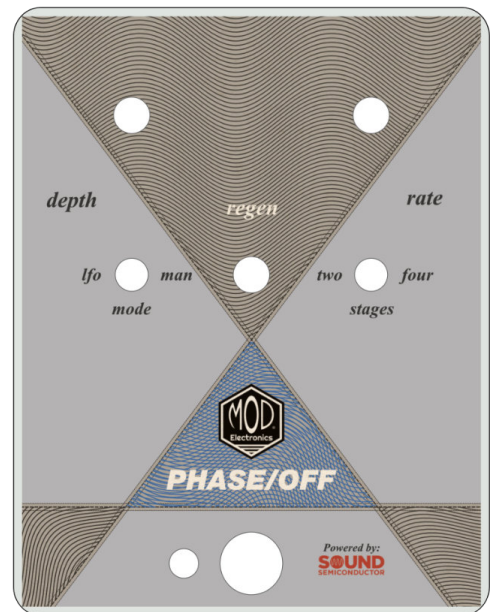

Main PCB Construction

Locate the Main PCB. The following steps will cover the placement and soldering of all parts that are mounted on this PCB. Use the BOM and Parts List as references.

Part 1: Resistors

1: Insert a 10K Ω resistor at R1. Its color bands are brown, black, black, red, brown.

2: Insert a 200 Ω resistor at R2. Its color bands are red, black, black, black, brown.

3: Insert a 10K Ω resistor at R3. Its color bands are brown, black, black, red, brown.

4: Insert a 10K Ω resistor at R4. Its color bands are brown, black, black, red, brown.

5: Insert a 200 Ω resistor at R5. Its color bands are red, black, black, black, brown. Solder these five resistors now.

6: Insert a 10K Ω resistor at R6. Its color bands are brown, black, black, red, brown.

7: Insert a 33K Ω resistor at R7. Its color bands are orange, orange, black, red, brown.

8: Insert a 10K Ω resistor at R8. Its color bands are brown, black, black, red, brown.

9: Insert the 5.1K Ω resistor at R9. Its color bands are green, brown, black, brown, brown.

10: Insert a 33K Ω resistor at R10. Its color bands are orange, orange, black, red, brown. Solder these five resistors now.

11: Insert a 10K Ω resistor at R11. Its color bands are brown, black, black, red, brown.

12: Insert a 10K Ω resistor at R12. Its color bands are brown, black, black, red, brown.

13: Insert the 13K Ω resistor at R13. Its color bands are brown, orange, black, red, brown.

14: Insert the 8.2K Ω resistor at R14. Its color bands are gray, red, black, brown, brown.

15: Insert a 100 Ω resistor at R15. Its color bands are brown, black, black, black, brown. Solder these five resistors now.

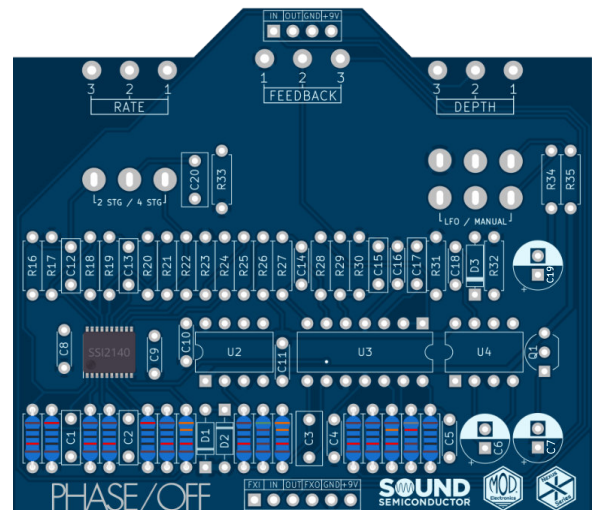
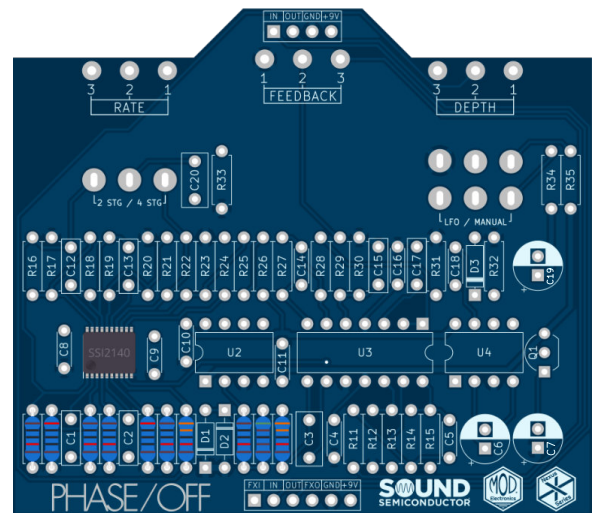
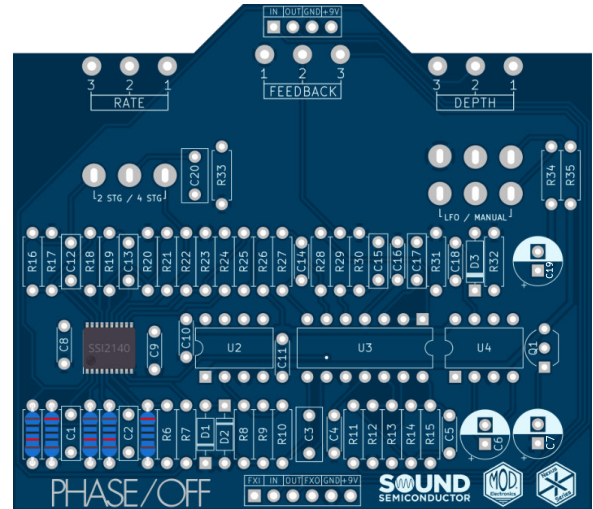

Main PCB Construction

Part 1: Resistors (cont.)

16: Insert a 10KΩ resistor at R16. Its color bands are brown, black, black, red, brown.

17: Insert a 200Ω resistor at R17. Its color bands are red, black, black, black, brown.

18: Insert a 10KΩ resistor at R18. Its color bands are brown, black, black, red, brown.

19: Insert a 10KΩ resistor at R19. Its color bands are brown, black, black, red, brown.

20: Insert a 200Ω resistor at R20. Its color bands are red, black, black, black, brown. Solder these five resistors now.

21: Insert a 10KΩ resistor at R21. Its color bands are brown, black, black, red, brown.

22: Insert a 16KΩ resistor at R22. Its color bands are brown, blue, black, red, brown.

23: Insert a 1KΩ resistor at R23. Its color bands are brown, black, black, brown, brown.

24: Insert the 100KΩ resistor at R24. Its color bands are brown, black, black, orange, brown.

25: Insert a 51KΩ resistor at R25. Its color bands are green, brown, black, red, brown. Solder these five resistors now.

26: Insert a 10KΩ resistor at R26. Its color bands are brown, black, black, red, brown.

27: Insert a 10KΩ resistor at R27. Its color bands are brown, black, black, red, brown.

28: Insert a 10KΩ resistor at R28. Its color bands are brown, black, black, red, brown.

29: Insert a 18KΩ resistor at R29. Its color bands are brown, gray, black, red, brown.

30: Insert a 10KΩ resistor at R30. Its color bands are brown, black, black, red, brown. Solder these five resistors now.

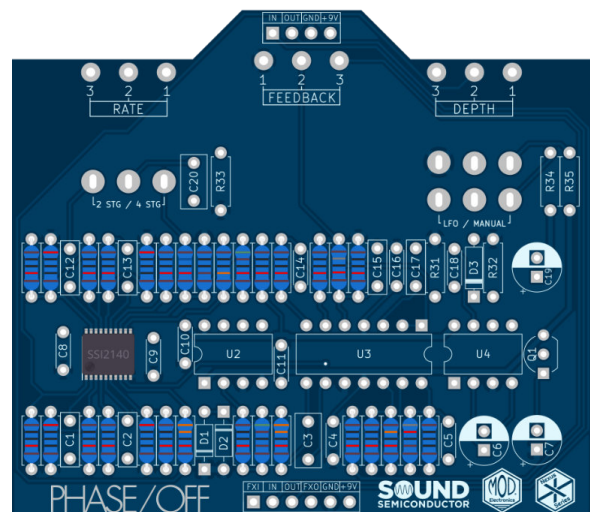
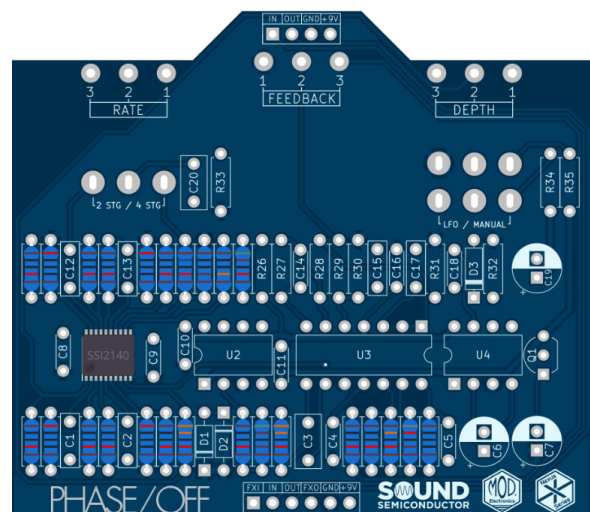
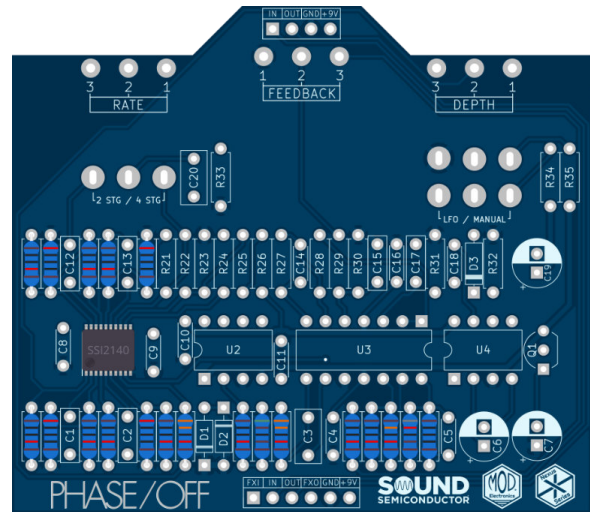

Main PCB Construction

Part 1: Resistors (cont.)

31: Insert a 1M Ω resistor at R31. Its color bands are brown, black, black, yellow, brown.

32: Insert a 3K Ω resistor at R32. Its color bands are orange, black, black, brown, brown.

33: Insert a 100 Ω resistor at R33. Its color bands are brown, black, black, black, brown.

34: Insert a 47K Ω resistor at R34. Its color bands are yellow, violet, black, red, brown.

35: Insert a 47K Ω resistor at R35. Its color bands are yellow, violet, black, red, brown. Solder these five resistors now.

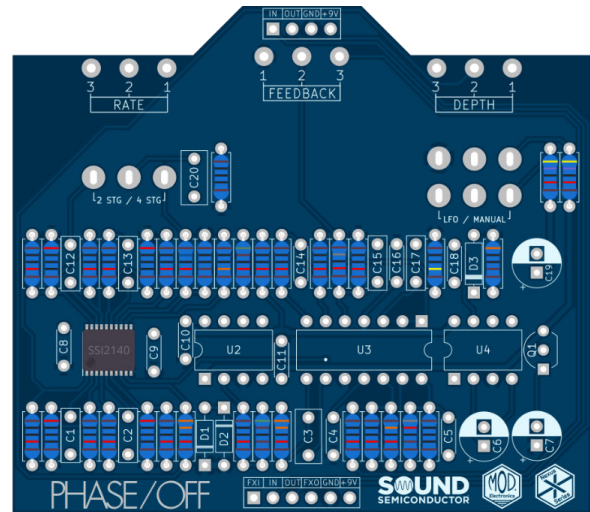

Part 2: Diodes

Locate the three diodes. When inserting each diode, note the orientation of the band. This should match the orientation on the silkscreen.

36: Insert a 1N4148 diode at D1.

37: Insert a 1N4148 diode at D2.

38: Insert the 1N5817 diode at D3. Solder these three diodes now.

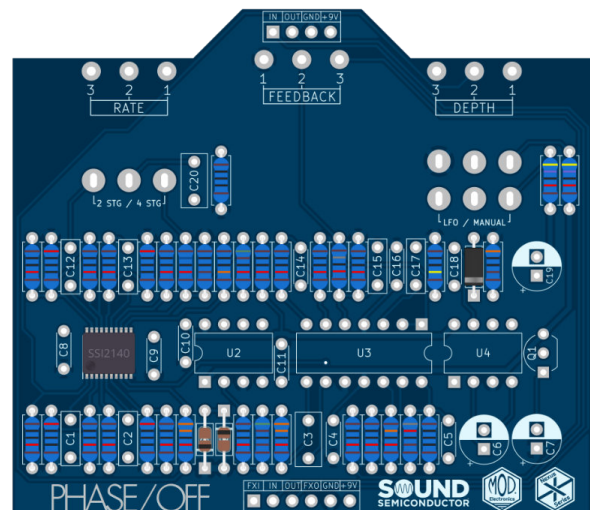
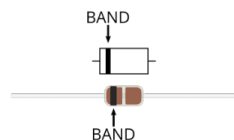

Part 3: IC Sockets & Transistor

39: Insert an 8-Pin DIP Socket at U2. Be sure to match the orientation on the silkscreen. Solder this now.

40: Insert a 14-Pin DIP Socket at U3. Be sure to match the orientation on the silkscreen. Solder this now.

41: Insert an 8-Pin DIP Socket at U4. Be sure to match the orientation on the silkscreen. Solder this now.

42: Insert the 2N2222A transistor at Q1. Be sure to match the orientation on the silkscreen. Solder this now.

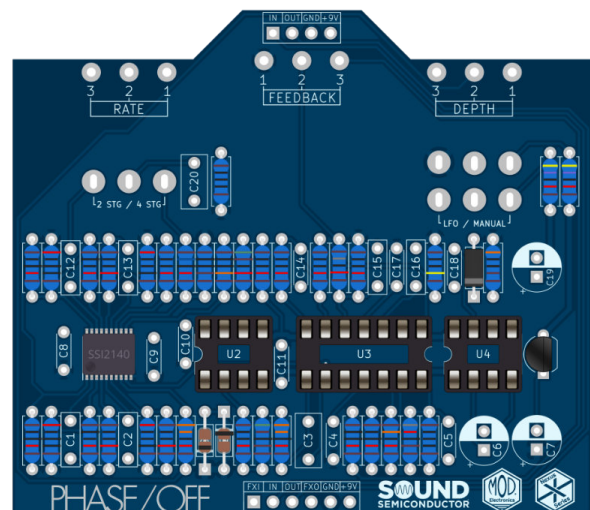

Main PCB Construction

Part 4: Capacitors

43: Insert a 1nF film capacitor at C1. This is the rectangular capacitor marked 1nj100.

44: Insert a 1nF film capacitor at C2. This is the rectangular capacitor marked 1nj100.

45: Insert a 470nF film capacitor at C3. This is the rectangular capacitor marked .47K63.

46: Insert a 100nF ceramic capacitor at C4. This is the circular capacitor marked 104.

47: Insert a 47pF ceramic capacitor at C5. This is the circular capacitor marked 47. Solder these five capacitors now.

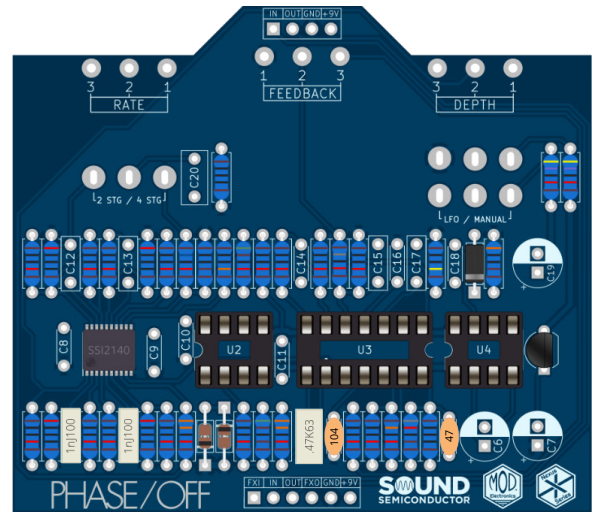

48: Insert a 100uF electrolytic capacitor at C6. When inserting the capacitor, note the orientation of the positive and negative lead.

49: Insert a 100uF electrolytic capacitor at C7. When inserting the capacitor, note the orientation of the positive and negative lead.

50: Insert a 100nF ceramic capacitor at C8. This is the circular capacitor marked 104.

51: Insert a 100nF ceramic capacitor at C9. This is the circular capacitor marked 104. Solder these four capacitors now.

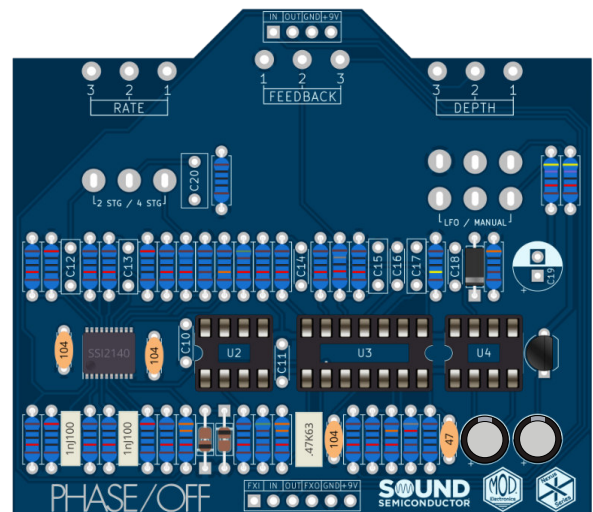
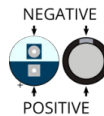

52: Insert a 100nF ceramic capacitor at C10. This is the circular capacitor marked 104.

53: Insert a 100nF ceramic capacitor at C11. This is the circular capacitor marked 104.

54: Insert a 1nF film capacitor C12. This is the rectangular capacitor marked 1nj100.

55: Insert a 1nF film capacitor at C13. This is the rectangular capacitor marked 1nj100.

56: Insert a 470pF ceramic capacitor at C14. This is the circular capacitor marked 471. Solder these five capacitors now.

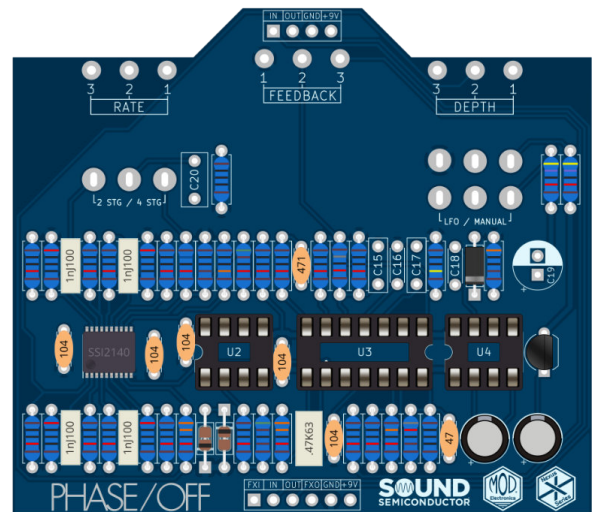

Main PCB Construction

Part 4: Capacitors (cont.)

57: Insert a 1.5nF film capacitor at C15. This is the rectangular capacitor marked 1n5K100.

58: Insert a 100nF ceramic capacitor at C16. This is the circular capacitor marked 104.

59: Insert a 100nF film capacitor at C17. This is the rectangular capacitor marked .1J100.

60: Insert a 10pF ceramic capacitor at C18. This is the circular capacitor marked 10.

61: Insert a 100uF electrolytic capacitor at C19. When inserting the capacitor, note the orientation of the negative lead. Solder these five capacitors.

62: Insert a 470nF film capacitor at C20. This is the rectangular capacitor marked .47K63. Solder this capacitor now.

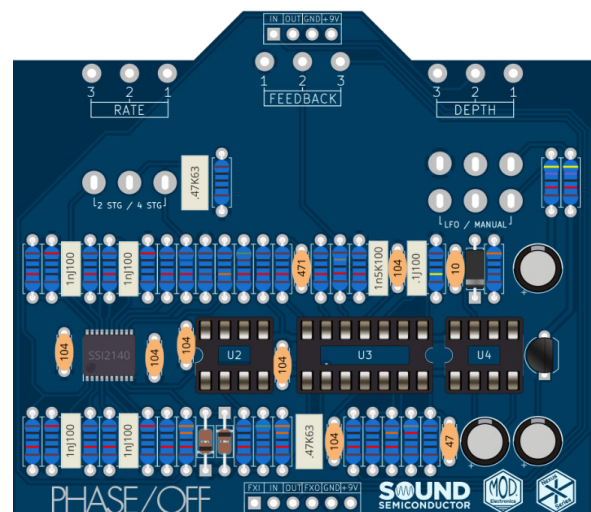
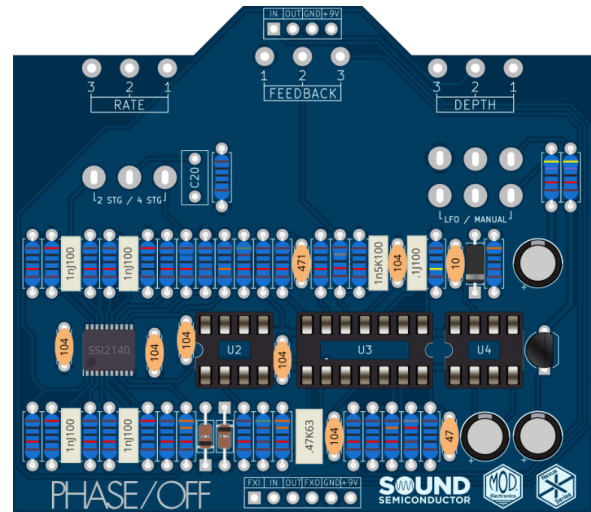

Main PCB Construction

Part 5: Switches and Potentiometers

63: Remove all of the mounting hardware and insert the SPDT mini toggle switch at SW1 on side 2 of the PCB.

64: Remove all of the mounting hardware and insert the DPDT mini toggle switch at SW2 on side 2 of the PCB. Don't solder these switches yet but make sure they are both fully inserted through the PCB.

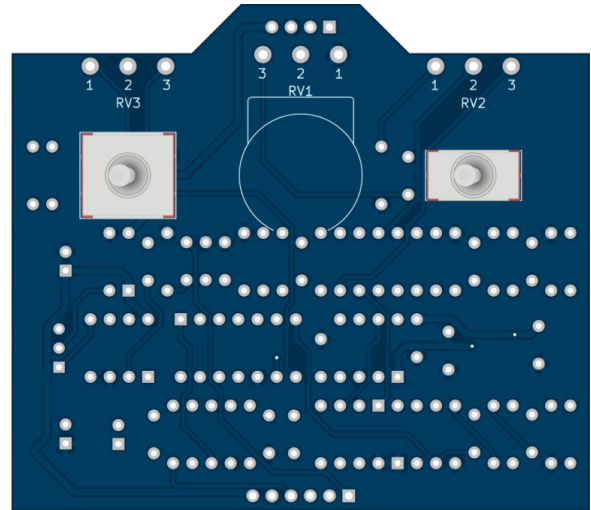

65: Locate the 3 potentiometers and remove all mounting hardware. Grip the small metal tab on each pot with a pair of pliers and gently rock the tab until it snaps off.

66: Slide the plastic cover onto the B10K potentiometer.

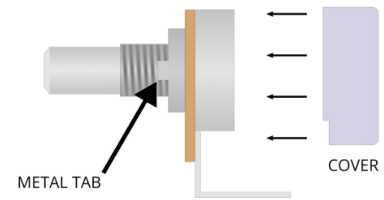

67: Locate the enclosure and mount the 3 pots as shown. Use the mounting hardware to hold each pot onto the enclosure but keep them loose enough to rotate.

68: Take the main PCB and delicately mount it to the enclosure by gently sliding the toggle switches through the two holes to the left and right of the B10K pot. As the toggles' bushings slide through the holes carefully guide the pots' pins into their mounting holes.

69: Attach and tighten the mounting hardware for both the switches and pots now. Use a single nut for the switches. Make sure the pots remain aligned and don't twist as you tighten the nut. This hardware only needs to be finger tight for now.

70: Make sure that the PCB is still flush to the switches. Solder both switches and all three pots now. Remove the mounting hardware and carefully remove the PCB from the enclosure.

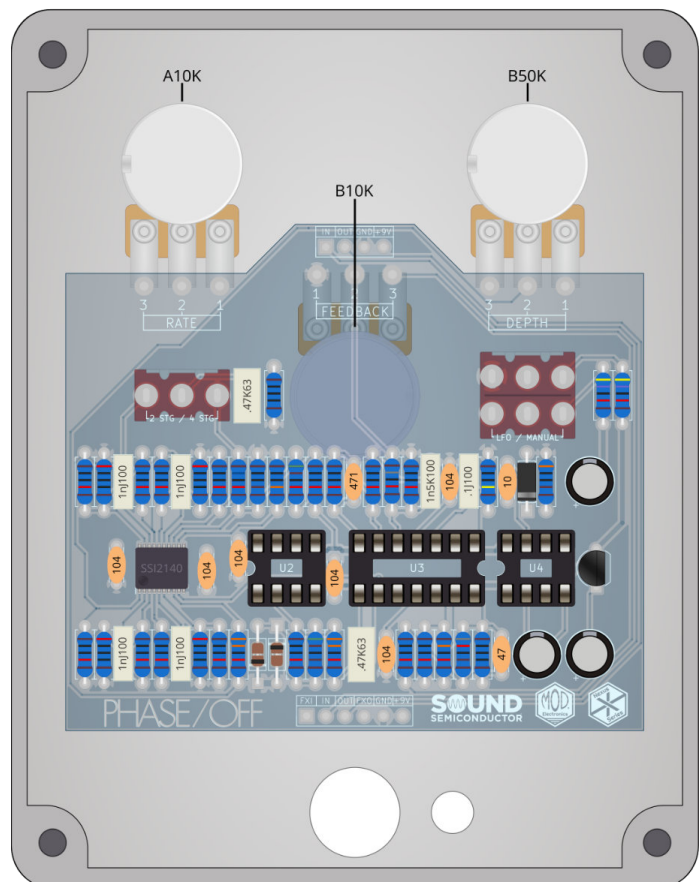

Footswitch PCB Construction

Locate the Footswitch PCB. The following steps will cover the placement and soldering of all parts that are mounted on this PCB. Use the BOM and Parts List as references.

Mount All Components

71: Insert the 1/8W 1K Ω resistor at RLED. Its color bands are brown, black, black, brown, brown. Solder the RLED resistor to the PCB.

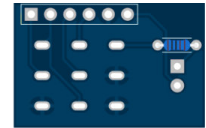

72: Insert the 3PDT footswitch into the 9 pin footprint on side 2 of the PCB. Solder the footswitch to the PCB.

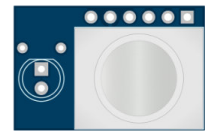

73: Apply the sticker to the enclosure now. See page 12 for instructions.

74: Once the sticker is completed, insert the LED lens into the small hole directly next to the large footswitch hole. Some force may be required. Slide the LED into the lens. The LED will lightly snap into place when fully inserted. Orient the LED so that the positive lead (longer lead) is on the bottom side of the enclosure and the negative lead (shorter lead) is on the top side when viewed from below.

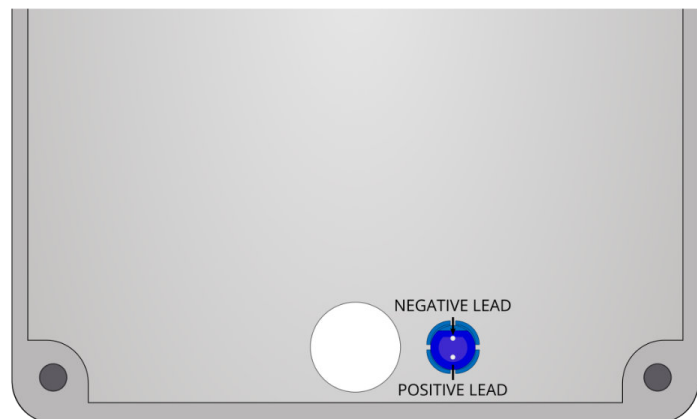
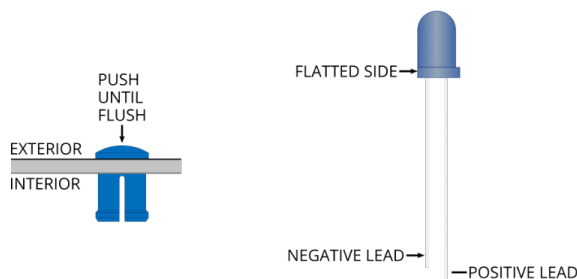

75: Remove the mounting hardware from the 3PDT footswitch. Carefully guide the LED leads through the LED + and LED - holes while inserting the footswitch bushing through the footswitch mounting hole at the bottom of the enclosure. The positive lead goes through the LED + hole and the negative lead goes through the LED - hole. When fully inserted, slide the metal flat washer over the bushing of the footswitch, then use the nut to secure the footswitch to the chassis. Finger tight will be good enough. Once secured, check to make sure the LED leads are straight, that the LED is fully inserted into the lens, and that the lens is flush to the exterior of the enclosure. Solder the LED to the PCB.

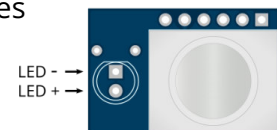

76: Once soldered, snip the excess LED leads from the pcb. Loosen the footswitch's mounting hardware and carefully remove the PCB from the enclosure. Be extra careful to avoid bending the LED leads.

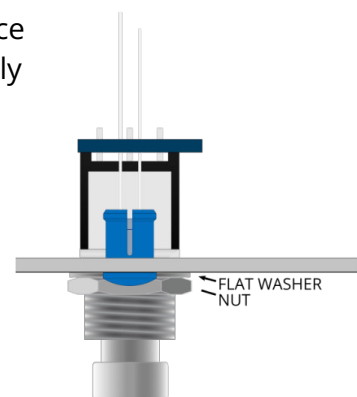

Jack PCB Construction

Locate the Jack PCB. The following steps will cover the placement and soldering of all parts that are mounted on this PCB. Use the BOM and Parts List as references.

Mount All Components

77: Cut and strip a one inch piece of both the black and white 24AWG wire. On side 2 of the Jack PCB, solder the white wire to the +9V pad and the black wire to the GND pad.

78: Mount the DC jack to the center hole of the top side of the enclosure. Finger tight is good enough. Orient the jack so the large center pin lug is to the left and the ring lug is to the right.

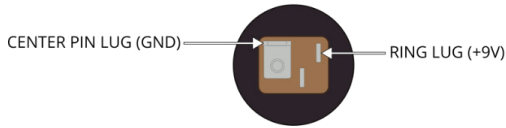

79: Mount the two 1/4" jacks to the holes left and right of the DC jack. Use the mounting hardware to hold each jack onto the enclosure but keep them loose enough to rotate. Orient them as shown to the right so the jacks will fit the PCB's footprints.

80: Slide the jack PCB onto the two mounted 1/4" jacks. Side 2 of the PCB with the outlines of the jacks faces the jack bodies and side 1 is facing away from them. When both are aligned and the board is fully flush to each of them, tighten the jacks so they no longer rotate. Solder all six of the 1/4" jack connections now.

81: Take the unconnected end of the black wire and connect it to the center pin lug of the DC jack. Take the unconnected end of the white wire and connect it to the ring lug of the DC jack. Solder both of these connections now.

82: Now that all of these connections are soldered, remove the jack PCB to prepare the enclosure for the final assembly.

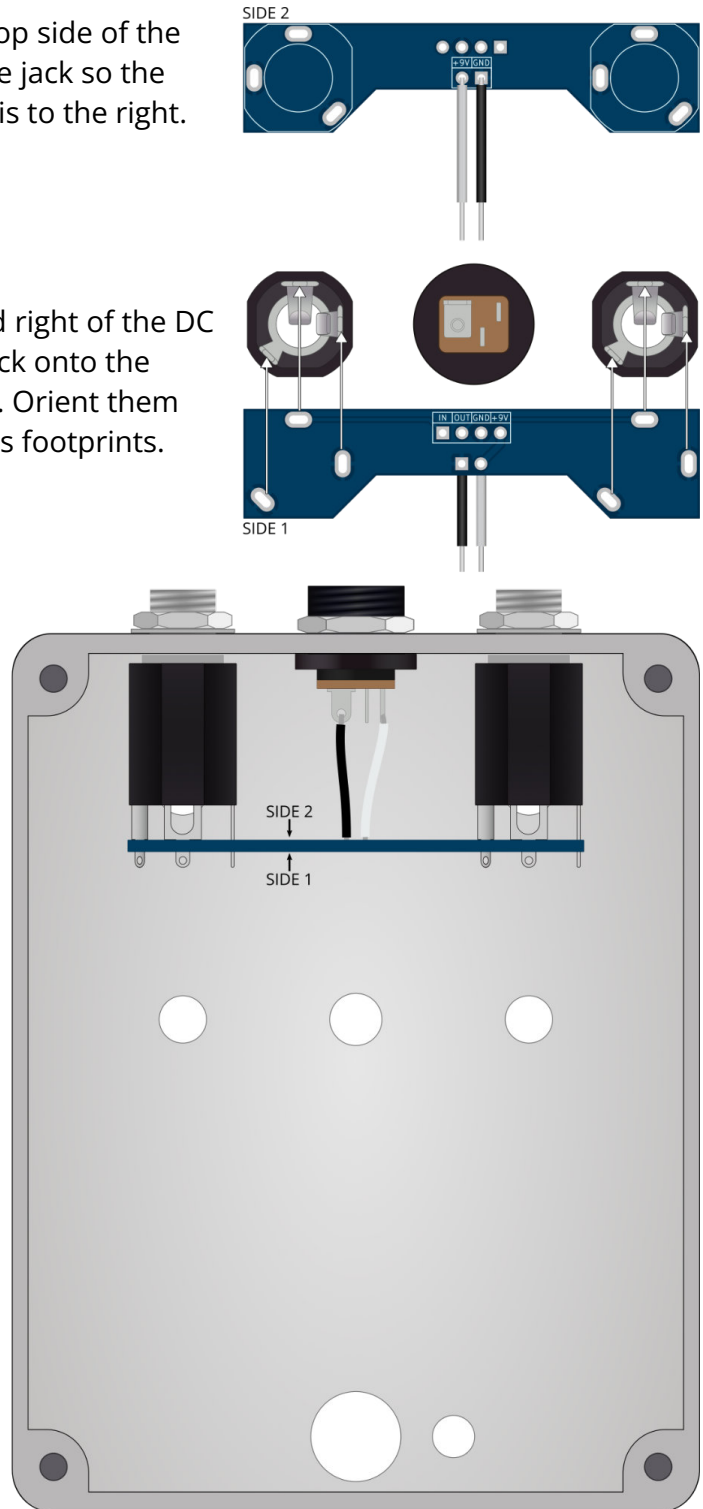

Final Assembly

Locate the three PCBs and the enclosure. The following steps will cover the final assembly of the pedal by connecting and mounting these three boards. Use the BOM and Parts List as references.

Part 1: Connect the Footswitch PCB to the Main PCB

83: Insert the 6 conductor ribbon cable through the six holes near the logos on side 1 of the main PCB. Solder all 6 connections now.

84: Insert the 4 conductor ribbon cable through the four holes near the feedback pot on side 1 of the main PCB. Solder all 4 connections now.

85: Insert the other side of the 6 conductor ribbon cable through the six holes on side 1 of the footswitch PCB. Solder all 6 connections now.

Now is a good time to check over the build to make sure no steps were missed and that all connections have been made.

Part 2: Attach the Footswitch PCB & the Main PCB to the Enclosure

86: Make sure that all mounting hardware has been removed from the pots and switches. Gently slide both boards into their mounting holes simultaneously. Be extra careful with the toggle switches and LED. Make sure that the LED leads do not bend and that the LED lens remains flush to the enclosure.

87: Once all parts are fully flush to the interior of the enclosure, begin attaching the mounting hardware. For the pots and footswitch, use a metal flat washer and then attach the nut. Use a single nut for the toggle switches. Make sure that the footswitch is not rotating as the nut is tightened down. Do not overtighten the mounting hardware.

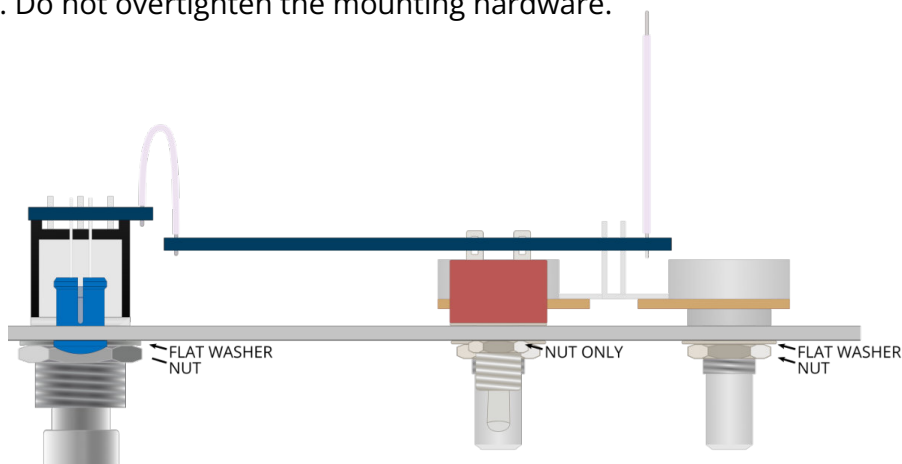
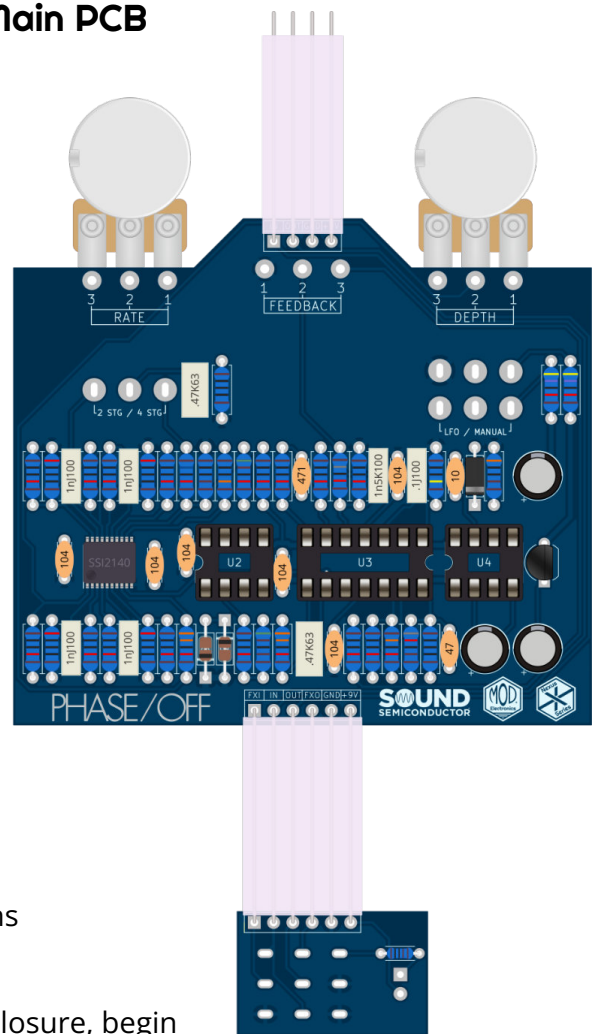

Final Assembly

Part 3: Attach the Jack PCB to the Enclosure

88: Mount the DC jack to the center hole of the top side of the enclosure. Orient the jack so the large center pin lug is to the left and the ring lug is to the right. Tighten down the mounting nut.

89: Now secure the jack PCB to the enclosure. Make sure it is oriented the same way as when the jacks were soldered. Use the flat washer first and then secure the nut to each 1/4" jack. Make sure that the 4 conductor ribbon cable does not get caught beneath the PCB.

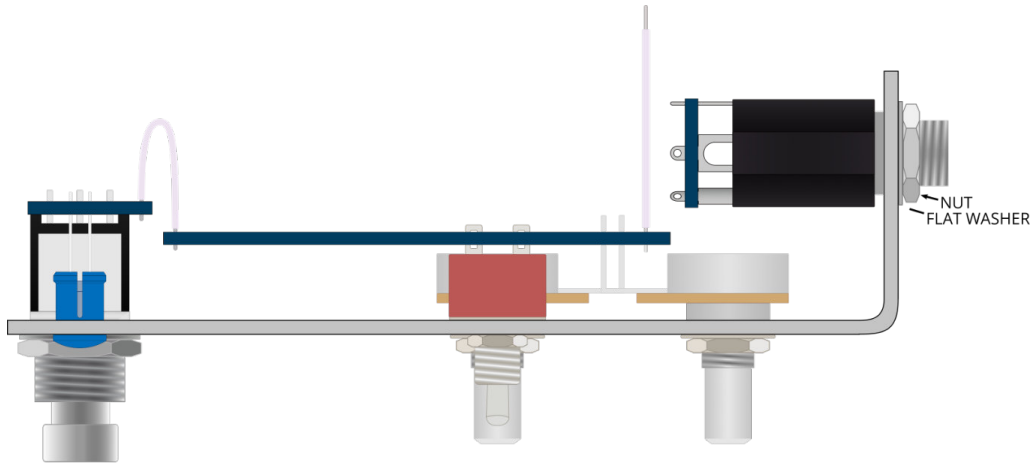

Part 4: Connect the Jack PCB to the Main PCB

90: With the jack PCB fully secured to the enclosure, insert the loose side of the 4 conductor ribbon cable through the four holes at the middle of side 1 of the jack PCB. Solder these four connections now. Be careful not to burn the black and white wires attaching the PCB to the DC jack.

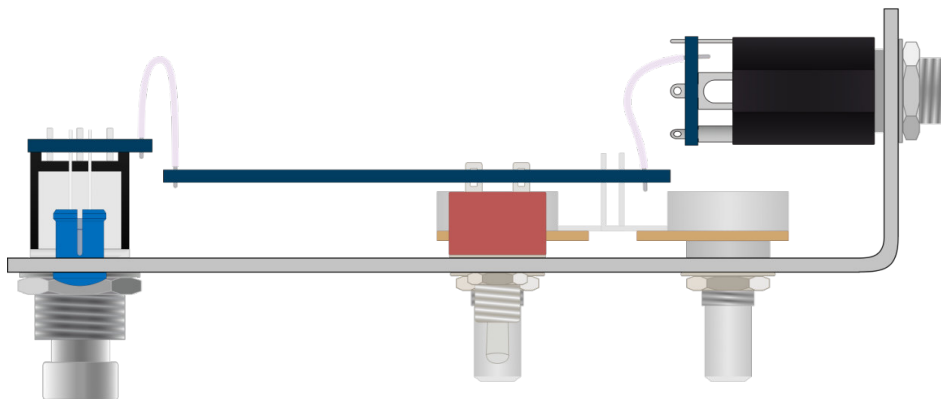

All soldering is completed. Now is a good time to check over the build to make sure no steps were missed and that all connections have been made.

Final Assembly

Part 5: Insert the ICs

91: Insert the LM311 in the U2 socket. Be sure to orient the IC correctly. The small dot on the top should be closest to the notch in the IC socket.

92: Insert the TL074 in the U3 socket. Be sure to orient the IC correctly. The small U-shaped notch on the top should be closest to the notch in the IC socket.

93: Insert the LT1054 in the U4 socket. Be sure to orient the IC correctly. The small dot on the top should be closest to the notch in the IC socket.

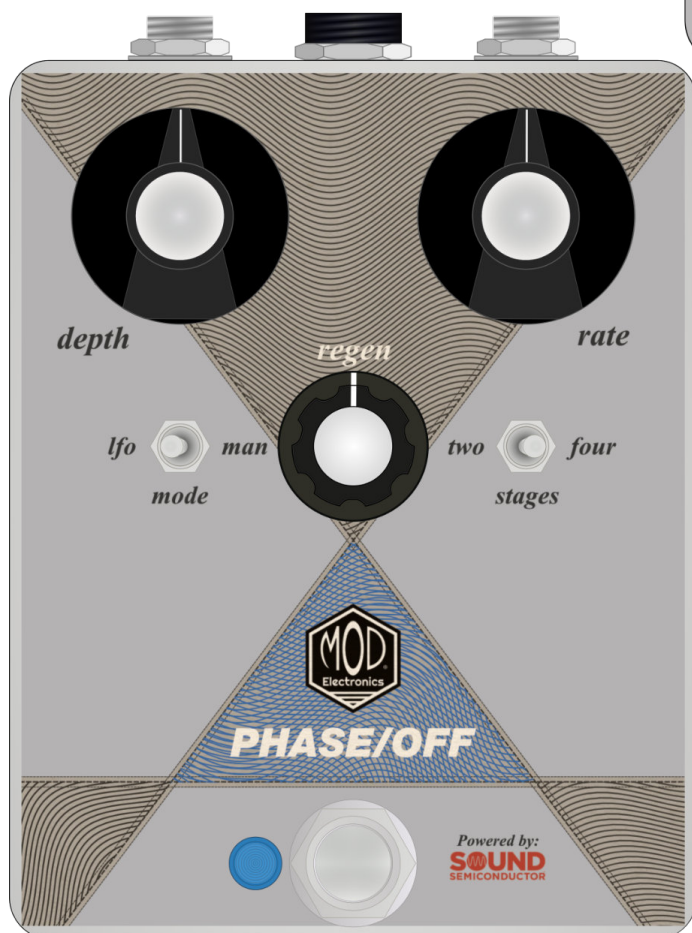
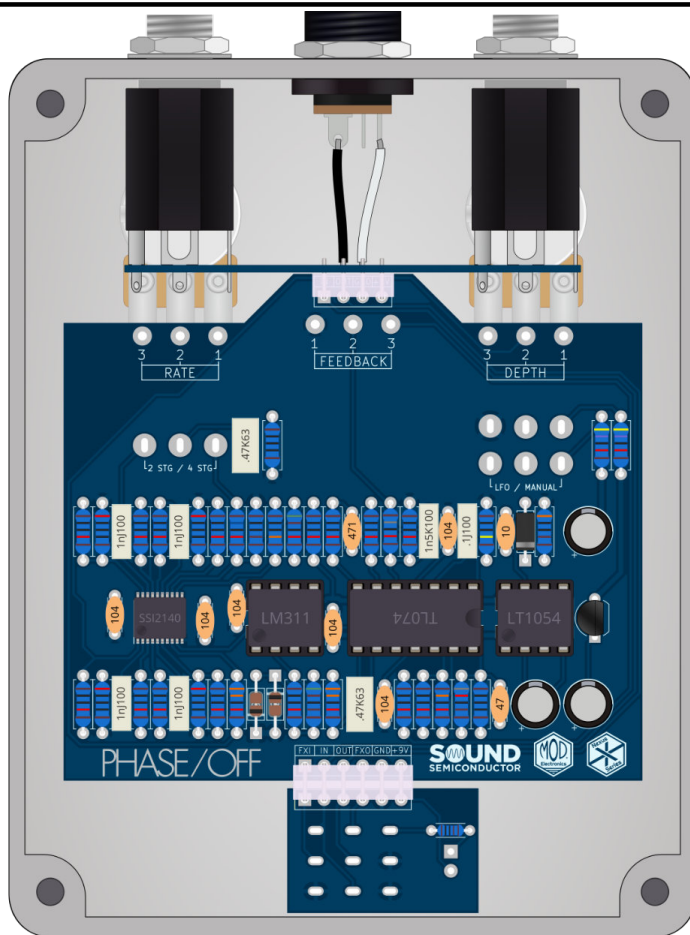

Part 6: Attach the Knobs

94: Secure the small knob to the pot shaft for the *Regen* control.

95: Secure one large knob to the pot shaft for the *Depth* control. Secure the other large knob to the pot shaft for the *Rate* control.

96: Take one more moment to examine the circuit boards. When fully satisfied with the work, use the four countersunk screws to attach the bottom to the enclosure. The pedal is now complete.

Phase / Off Controls

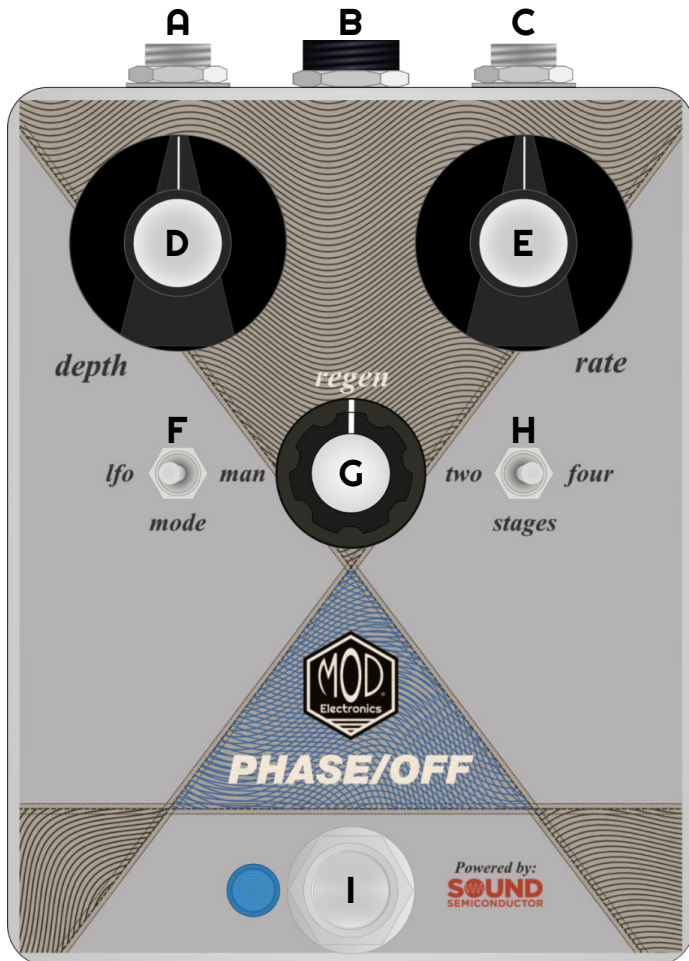

A Effect Output

B Power Input - 9VDC Center Negative

C Effect Input

D *Depth Control* - In *LFO Mode* this knob sets the amount of modulation. Counterclockwise for zero modulation and clockwise for full modulation. In *Manual Mode* this knob sets the static phase amount.

E *Rate Control* - In *LFO Mode* this knob sets the frequency of the modulation. Counterclockwise for the slowest speed and clockwise for the fastest. In *Manual Mode* this knob is disabled.

F *Mode Switch* - In *LFO Mode* the Phase Off is a classic style phaser with a triangle LFO modulating the phase of the signal. In *Manual Mode* the LFO is disabled and the *Depth* control sets a static phase for unique filtering effects.

G *Regen Control* - Sets the amount of signal feedback for adding resonance. Counterclockwise for no feedback and clockwise for full feedback. The *Regen* control is active in both *Modes*.

H *Stages Switch* - Sets the total number of phase stages. The *2 Stage* setting results in a single notch. The *4 Stage* setting results in two notches.

I *Footswitch* - True bypass footswitch for effect on/off. The blue LED is illuminated when the effect is on.

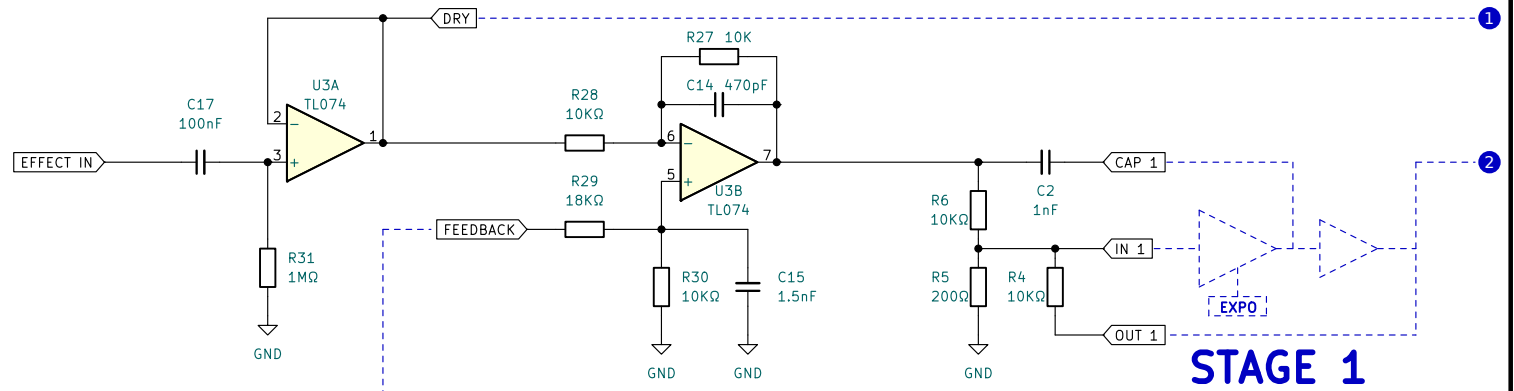

STAGE 1

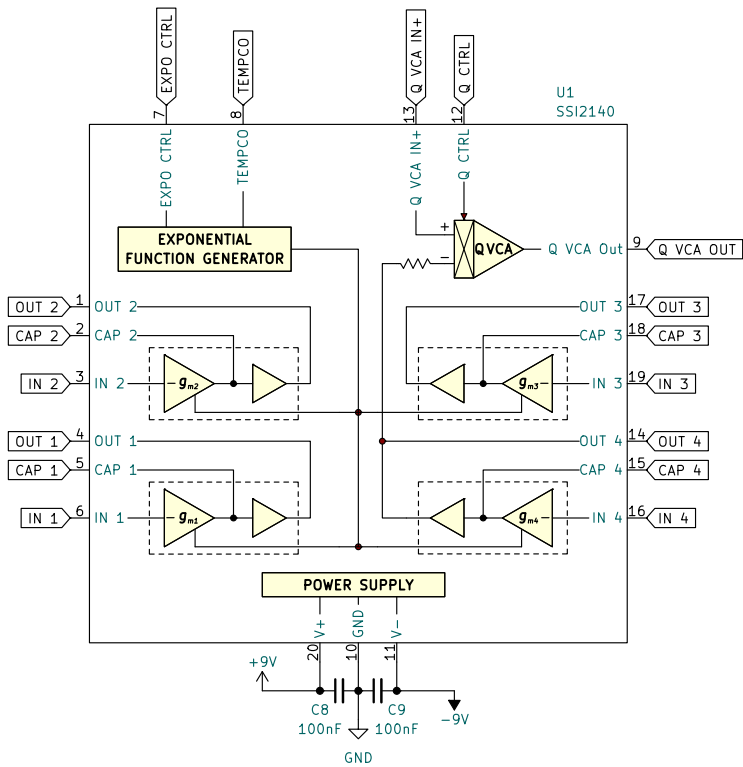

Copyright © 2023 By Mod® Electronics

**Phase / Off (K-905)
Main PCB Schematic 1/3**

1

4

2

5

6

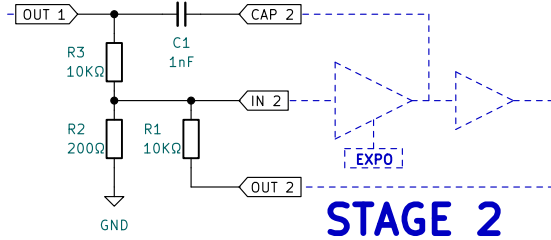

STAGE 2

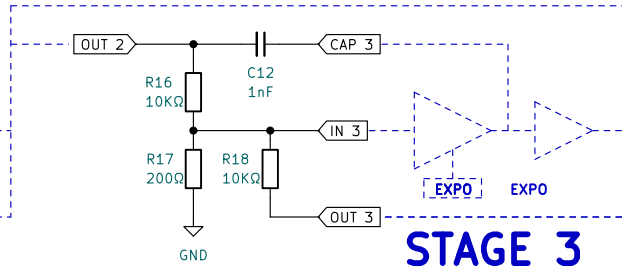

STAGE 3

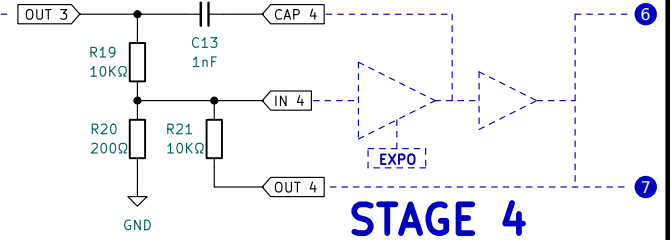

STAGE 4

3

8

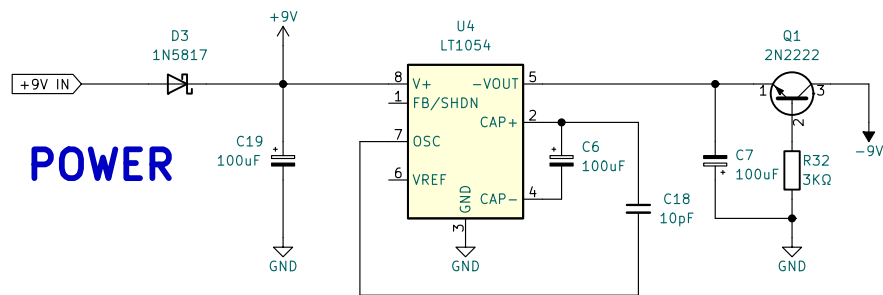

POWER

LM311 BYPASS CAPS

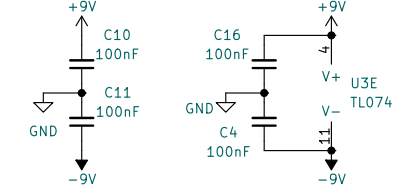

Copyright © 2023 By Mod® Electronics

Phase / Off (K-905)
Main PCB Schematic 2/3

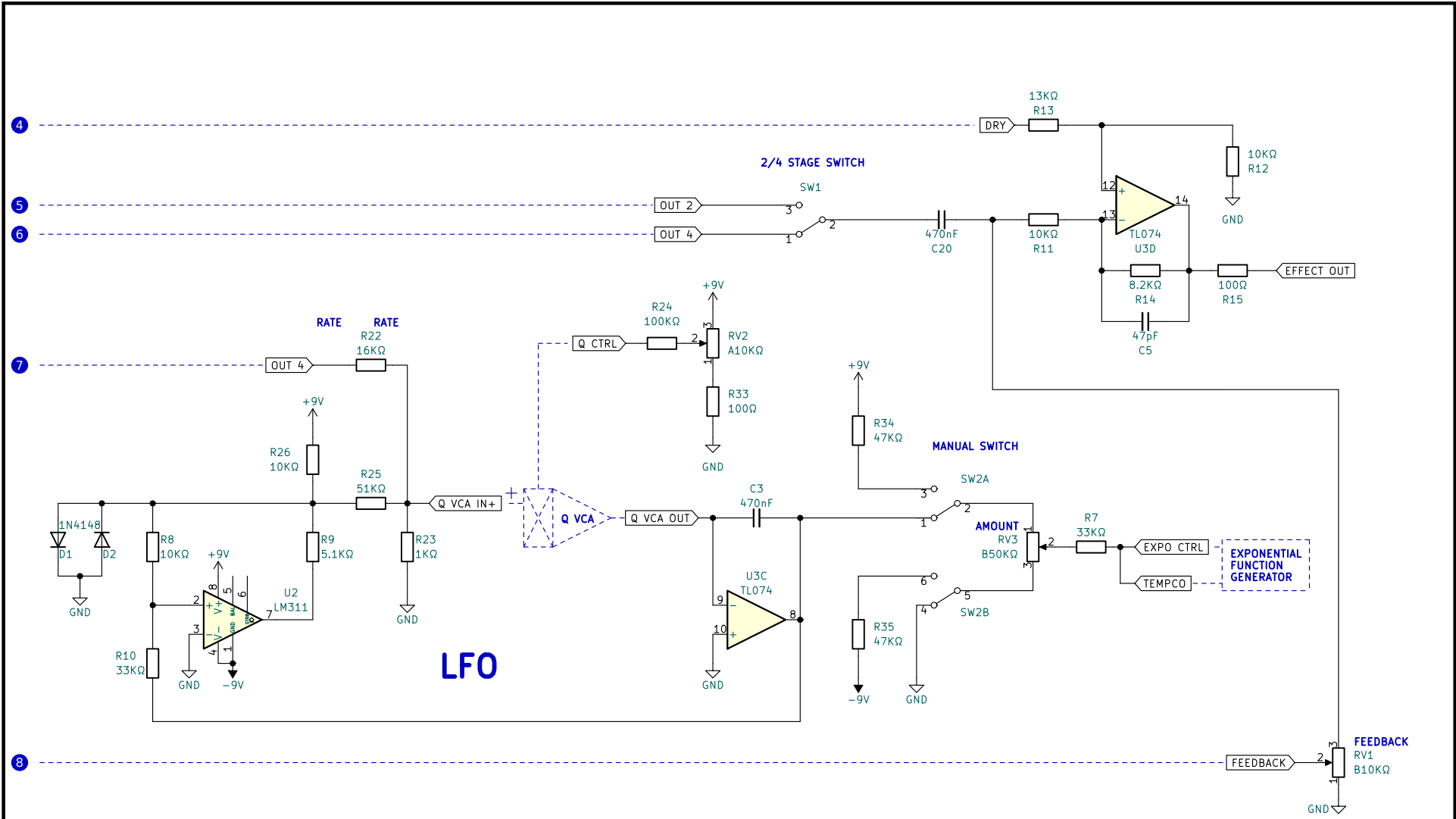

Copyright © 2023 By Mod® Electronics

Phase / Off (K-905)
Main PCB Schematic 3/3