

DIMENSIONS:

A	2.500" ±0.063
B	3.685" ±0.125
C	3.080" ±0.063
D	2.000" ±0.063
E	2.888" ±0.063
G	0.203" x 0.375" ±0.015

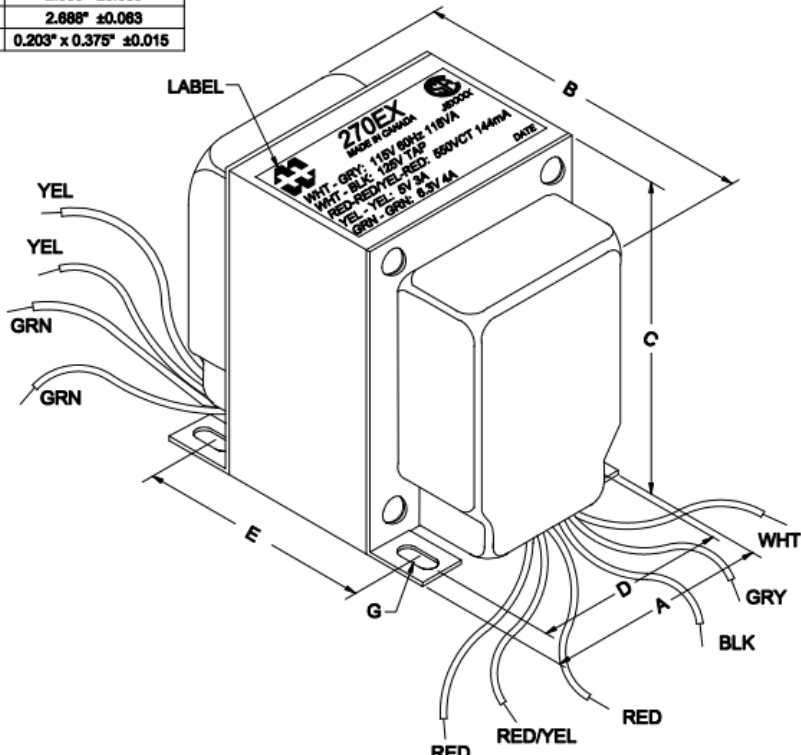

NOTE: ALL LEADS 6" OUT MIN. STRIPPED 0.5"

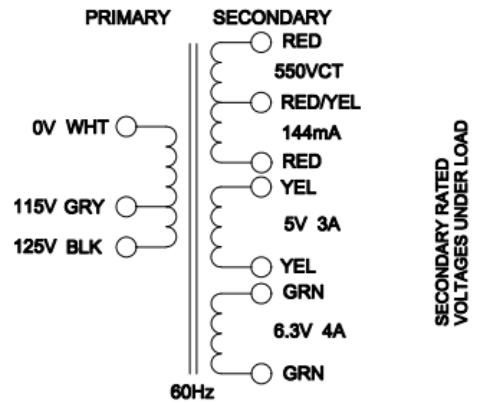

ELECTRICAL DATA:

TESTS	CONDITIONS	ACCEPTANCE CRITERIA
Iex	@ 125V, 60Hz, WHT - BLK	283.2mA Max.
Sec. N.L.V	@ 125V, 60Hz, WHT - BLK	
	RED - RED =	598.5V ±2%
	RED - RED/YEL = RED/YEL - RED =	299.3V ±2%
	YEL - YEL =	5.474V ±2%
	GRN - GRN =	6.843V ±2%
DCR	@ 20°C, WHT - BLK =	2.730 Ω ±20%
	@ 20°C, RED - RED =	99.68 Ω ±20%
	@ 20°C, YEL - YEL =	0.063 Ω ±20%
	@ 20°C, GRN - GRN =	0.052 Ω ±20%
HIPOT	PRIMARY - SECONDARY	2000V, 60Hz, 1 SEC