

DIMENSIONS:	
A	3.125" ±0.063
B	3.936" ±0.125
C	3.800" ±0.063
D	2.500" ±0.063
E	2.888" ±0.063
G	0.203" x 0.400" ±0.015

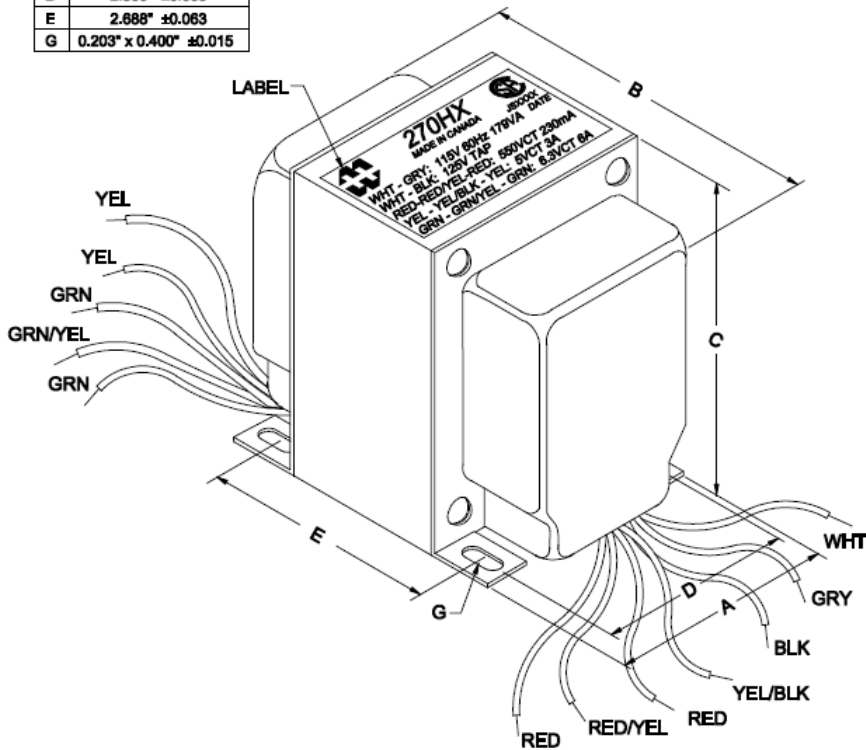

NOTE: ALL LEADS 6" OUT MIN. STRIPPED 0.5"

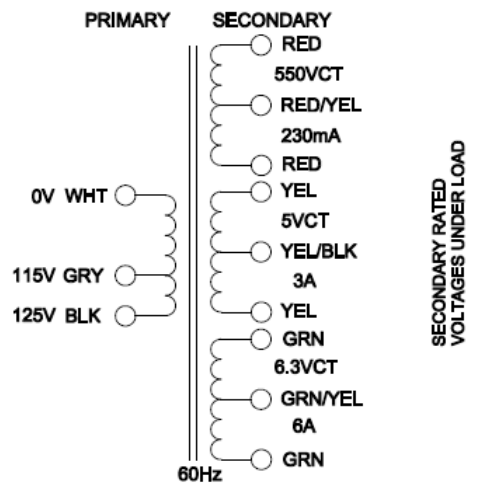

ELECTRICAL DATA:		
TESTS	CONDITIONS	ACCEPTANCE CRITERIA
I _{ex}	@ 125V, 60Hz, WHT - BLK	361.2mA Max.
Sec. N.L.V	@ 125V, 60Hz, WHT - BLK	
	RED - RED =	582.2V ±2%
	RED - RED/YEL = RED/YEL - RED =	296.1V ±2%
	YEL - YEL =	5.392V ±2%
	YEL - YEL/BLK = YEL/BLK - YEL =	2.696V ±2%
	GRN - GRN =	6.863V ±2%
	GRN - GRN/YEL = GRN/YEL - GRN =	3.431V ±2%
DCR	@ 20°C, WHT - BLK =	1.345 Ω ±20%
	@ 20°C, RED - RED =	59.03 Ω ±20%
	@ 20°C, YEL - YEL =	0.039 Ω ±20%
	@ 20°C, GRN - GRN =	0.043 Ω ±20%
HIPOT	PRIMARY - SECONDARY	2500V, 60Hz, 1 SEC