

DIMENSIONS:	
A	2.250" ±0.063
B	2.813" ±0.063
C	3.875" ±0.125
D	1.873" ±0.063
F	2.435" ±0.063
G	1.560" ±0.063
H	3.375" ±0.063
J	2.813" ±0.063

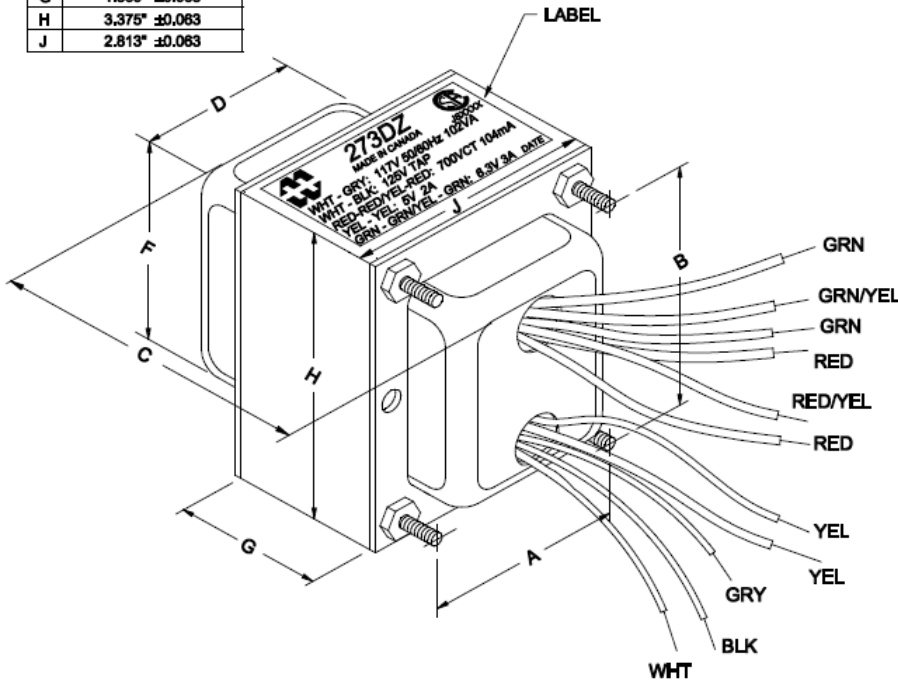

NOTE: ALL LEADS 6" OUT MIN. STRIPPED 0.5"

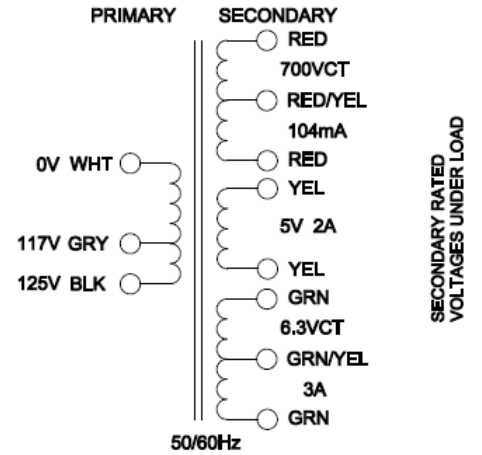

ELECTRICAL DATA:		
TESTS	CONDITIONS	ACCEPTANCE CRITERIA
I _{ex}	@ 125V, 60Hz, WHT - BLK	165.6mA Max.
Sec. N.L.V	@ 125V, 60Hz, WHT - BLK	
	RED - RED =	738.3V ±2%
	RED - RED/YEL = RED/YEL - RED =	369.2V ±2%
	YEL - YEL =	5.510V ±2%
	GRN - GRN/YEL = GRN/YEL - GRN =	3.444V ±2%
	GRN - GRN =	6.887V ±2%
DCR	@ 20°C, WHT - BLK =	3.046 Ω ±20%
	@ 20°C, RED - RED =	169.8 Ω ±20%
	@ 20°C, YEL - YEL =	0.085 Ω ±20%
	@ 20°C, GRN - GRN =	0.070 Ω ±20%
HIPOT	PRIMARY - SECONDARY	2000V, 60Hz, 1 SEC